

HIRSCHMANN

# *maestro*

## Operator's Console



### Contents

General Information

1

Important Notes

2

System Description

3

Settings

4

Pre-operation  
Inspection

5

Service and  
Maintenance

6

Troubleshooting

7

Appendix

## User Manual

**Issue 3/2005 Rev. B**

This document has the order no.  
50 160 19 0009e\_418338 (001)

## CONTENTS

<b>1. General Information</b> .....	3
<b>2. Warnings</b> .....	4
<b>3. System Description</b> .....	5
3.1 System functions .....	6
3.2 Operator's console .....	7
3.3 Displays and operational controls .....	8
<b>4. Configuration Setup</b> .....	16
4.1 Setting up the system to the actual configuration .....	16
4.1.1 Setting up the operating mode/reeving (with text menus) .....	17
4.1.2 Setting up the operating mode (without text menus) .....	19
4.1.3 Setting up the reeving (quick setting up with text menus) .....	20
4.1.4 Setting up the reeving (quick setting up without text menus) .....	20
4.2 Geometry restrictions .....	21
4.2.1 Restricting the boom head height .....	23
4.2.2 Restricting the boom angle .....	25
4.2.3 Restricting the boom radius .....	27
<b>5. Pre-operation Inspection</b> .....	29
5.1 Operation .....	30
<b>6. Service and Maintenance</b> .....	31
<b>7. Troubleshooting</b> .....	32
7.1 General information .....	32
7.2 Fault notifications (Error code table) .....	33
<b>Important information for crane operators and users</b> .....	39

System description

## 1. GENERAL INFORMATION

This manual describes the function, operation and maintenance of the Load Moment Indicator<sup>1</sup> (LMI) HIRSCHMANN **maestro**.

The HIRSCHMANN **maestro** has been designed to provide the crane operator with the essential information required to operate the machine within the design parameters specified by the manufacturer. The LMI provides the operator with information regarding the length and angle of the boom, wheel head height, working radius, rated load and the total weight being lifted by the crane.

The HIRSCHMANN **maestro** system consists of a central microprocessor unit, a display and operator's console, and various sensors for recording the measured values. The system operates on the principle of reference/real comparison. The real value, resulting from the load measurement, is compared with the reference data stored in the central processor memory and evaluated by the microprocessor. As soon as non-permitted operating conditions are approached, the HIRSCHMANN **maestro** LMI will warn the operator by sounding an audible alarm, lighting a warning light and switching off those movements that may aggravate or worsen the crane's load condition.

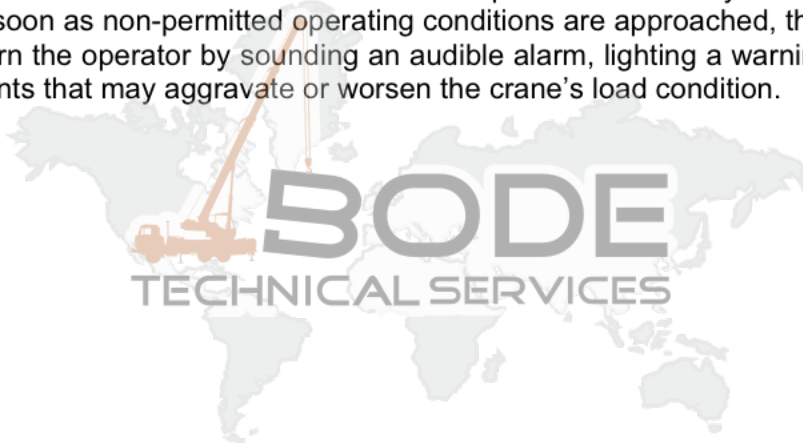

*The information in this document is subject to change without notice. PAT undertakes no warranty of any kind with regard to this material, including, but not limited to the implied warranties of merchantability and fitness for a particular purpose. PAT shall not be liable for errors contained herein or for incidental or consequential damages in connection with the furnishing and use of this manual. This document contains proprietary information, which is protected by copyright. All rights reserved. No part of this document may be photocopied, reproduced, or translated into another language without the prior written consent of PAT.*

---

<sup>1</sup> Load moment: generally the product of a force and a moment arm; specifically, the product of the load and the load-radius. Used in the determination of the lifting capacity of a crane.

System description

## 2. WARNINGS

The HIRSCHMANN *maestro* LMI is an operational aid, which warns a crane operator of imminent overload conditions, in order to prevent damage to equipment and personnel.

The device is not, and is not intended to be a substitute for good operator judgment, experience and use of accepted safe crane operating procedures.



**The responsibility for the safe operation of the crane shall remain with the operator who shall ensure that all warnings and instructions supplied are fully understood and observed. Prior to operating the crane, the operator must carefully and thoroughly read and understand the information in this manual to ensure that he knows the operation and limitations of the LMI and crane.**

**Proper functioning depends upon proper daily inspection and observance of the operating instructions set forth in this manual. Refer to chapter 5 of this handbook: Pre-Operation Inspection.**

 The logo for BODE TECHNICAL SERVICES, featuring a stylized crane icon on the left and the text "BODE" in large, bold, grey letters above "TECHNICAL SERVICES" in smaller, grey letters. The background is a faint world map.



## System description

**WARNING**

The LMI can only work correctly, if all adjustments have been properly set, i.e. the relevant operating mode and the reeving number have been input in accordance with the actual configuration. To prevent material damage and serious or even fatal injuries to staff, the correct adjustment of the LMI has to be ensured before starting the crane operation.

It is imperative that the operational and safety instructions as well as the load charts provided by the crane manufacturer, particularly for specific operating conditions and load limits, are always referred to.

**WARNING**

This system is equipped with a bypass function, which bypasses the switching-off of the control lever function by the LMI or the A2B switch (-es). The bypass control switches must only be activated in emergencies and by authorised staff. Failure to comply with this instruction can result in material damage and serious or even fatal injuries to staff.



**BODE**  
TECHNICAL SERVICES

System description

### 3. SYSTEM DESCRIPTION

The HIRSCHMANN *maestro* LMI system consists of a central microprocessor unit, a display and operator's console, and various sensors for recording the measured values.

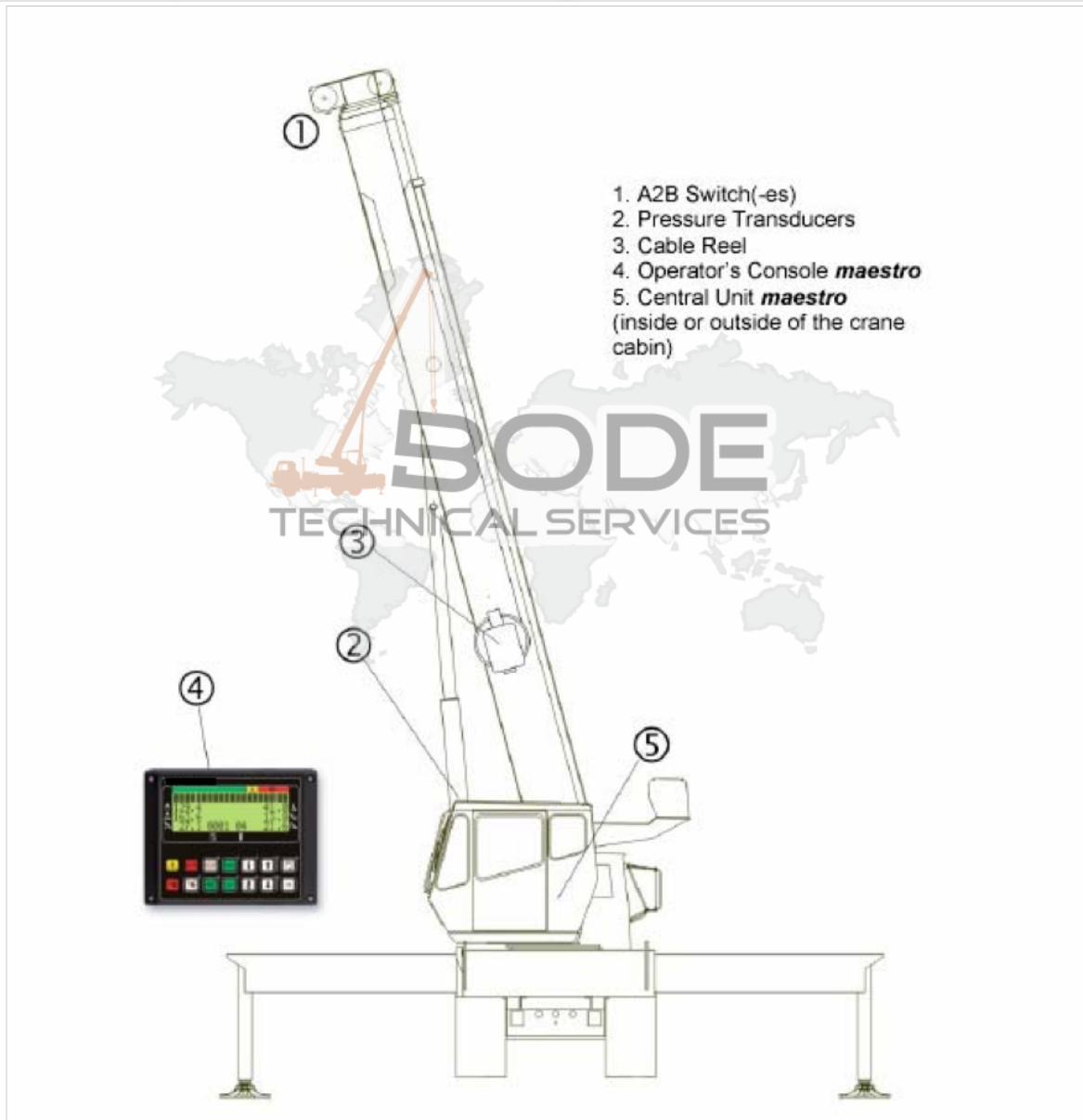

Fig. 1: Components of the LMI System HIRSCHMANN *maestro* (system example)



System description

### 3.2 Operator's console

The console has two functions:

- inputs in the LMI system by the crane operator (e.g. operating mode, reeving)
- display of important data and information

The **maestro** operator's console is mounted in the crane cabin within the operator's field of vision. For better legibility of the display this is backlit during operation. The console contains different displays and operational controls, which are described individually in chapter 3.3.

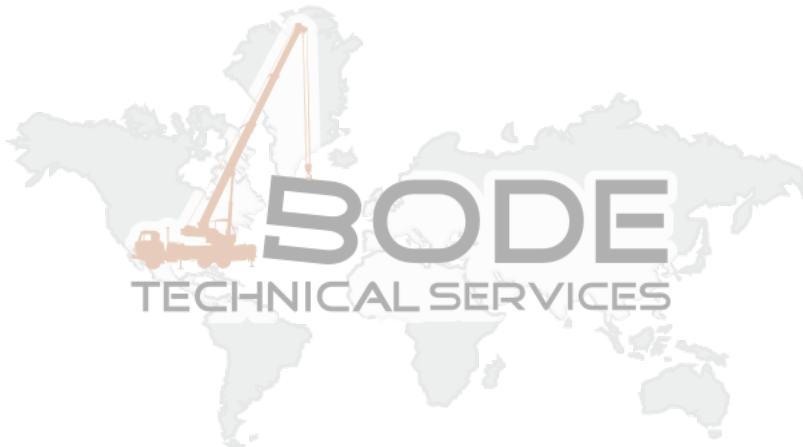

## System description

### 3.3 Displays and operational controls

The illustration shows the displays and operational controls of the HIRSCHMANN *maestro* console. The numbers in the illustration correspond to the numbers in the following functional description for each control.

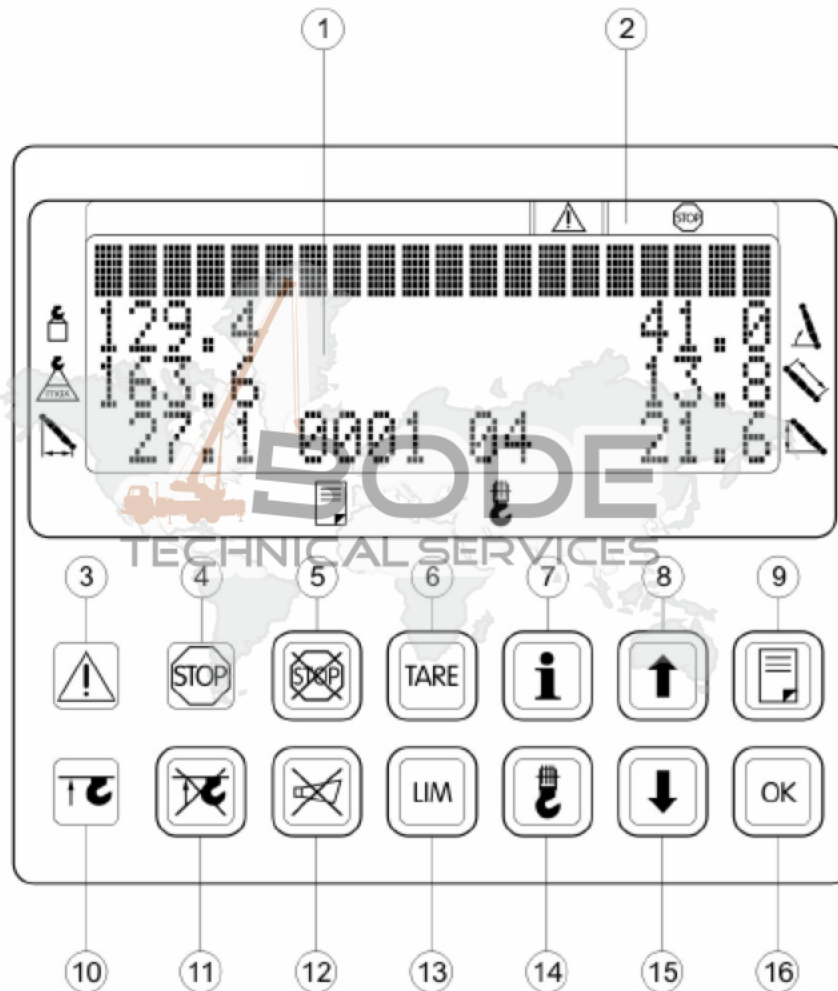

- |   |                                         |    |                                             |
|---|-----------------------------------------|----|---------------------------------------------|
| 1 | Data display (backlit)                  | 9  | Button "Program LMI"                        |
| 2 | Bar graph colour markings (utilisation) | 10 | Indicator light "A2B"                       |
| 3 | Indicator light "Prewarning overload"   | 11 | Indicator light/button bypass "A2B"         |
| 4 | Indicator light "Overload"              | 12 | Confirmation key for audible alarm          |
| 5 | Indicator light/button "Bypass LMI"     | 13 | Button "LIM" (Geometry limits)*             |
| 6 | Button "Tare"                           | 14 | Button "Select reeving"                     |
| 7 | Button "Information" *                  | 15 | Selection key "Down"                        |
| 8 | Selection key "Up"                      | 16 | Button <OK> e.g. for confirmation of inputs |

\* function not available with all systems

## Displays and operational controls

## (1) Data display

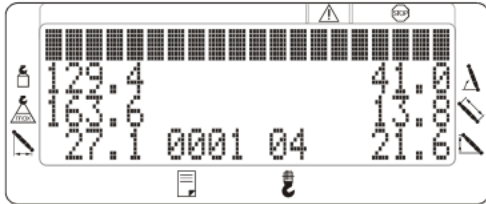

The *Data display* (1) used in **maestro** operator's console is a liquid-crystal display (LCD) with a wide temperature-range and transfective characteristics that give it a high legibility in bright sunlight and during backlit night operation.

LC displays work on the principle of the polarization of light. It should therefore be noted that dual polarizations that are at a certain angle to each other can reduce the legibility, even completely eliminating it. This effect can occur, if the crane operator is wearing polarized sunglasses.

In this case, the crane operator should work without sunglasses or use different sunglasses that do not have this characteristic.

The LCD contains an automatic temperature-controlled contrast adjustment to ensure the best possible display quality.

The following image shows the display during normal operating. (The values are not real; the tele indicator values can only be shown for systems with telescoping control.)





Displays and operational controls

**Data display (example):**

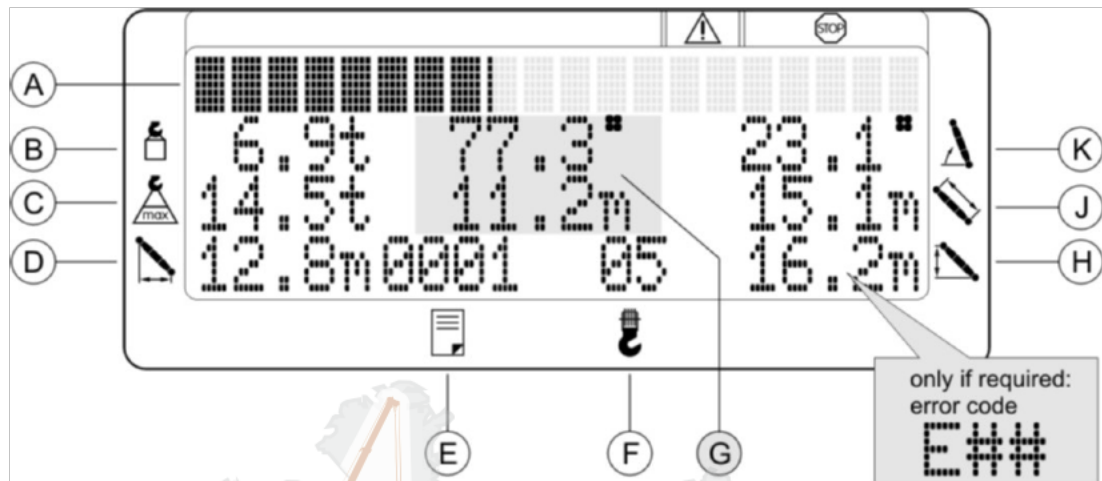

- A) Utilisation display (bar graph)
- B) Actual load
- C) Maximum load
- D) Boom radius
- E) Operating mode code
- F) Reeving number
- G) Boom jib values \*
- H) Boom head height
- J) Boom length
- K) Boom angle

\* This field "Boom jib" is only displayed for cranes with boom jib / derrick jib point / boom extension.

77.3° = example value here **point angle** to the horizontal in degrees

11.2m = example value here **point length** in metres

**Note:**

The display content is dependent on the system program used.

An error code will be displayed in field H) in the form **E##** in the event of an error.

## (2) Bar graph utilisation display



The utilisation display (*bar graph*) indicates how much of the permissible capacity (rated capacity) is being used. As the rated capacity changes continually during the loader operation the utilisation display will constantly change as well.

The bar graph is marked with different colours:

green:	“safe” area	(0...90% of the rated capacity)
yellow:	“prewarning area”	(90...100% of the rated capacity)
red:	“overload area”	(> 100% of the rated capacity)

## (3) “Prewarning utilisation” indicator light



This yellow indicator light will light up when the load on the crane has reached the defined pre-warning area. **An overload condition could therefore be imminent!**

At the same time the audible alarm sounds with an intermittent signal.

SOLO TECHNICAL SERVICE **IMPORTANT**

**This means that the operator may only continue the crane operation with caution.**

## (4) “Overload” indicator light



The lighting up of this red warning lamp indicates that the maximum load has been reached or exceeded.

At the same time the audible alarm sounds with a continuous signal and dependent on the system wiring the following crane movements, which increase the load moment are switched off:

- Lift load
- Lower boom
- Telescoping (with telescopic cranes)

After a 5 second warning the audible alarm can be suppressed by activating the  key.

Displays and operational controls

### (5) “Bypass LMI” control switch/indicator lamp



This control switch must only be activated in emergencies and only by authorised staff.

This control serves a dual purpose:

- The cut-off function of the LMI is bypassed during the period of activation of this switch.
- This indicator light flashes during the bypassing of the cut-off function of the LMI system.



Since this control switch deactivates the cut-off function of the LMI system, it is imperative that the following instructions are complied with:

- The bypass control switch should only be used in emergencies, as inappropriate bypassing can result in accidents and injury to persons.
- Never use this bypass control switch to either overload or operate the crane outside of the permitted crane specification.

### (6) “Tare” button



The button “TARE” (6) serves to output the net load on the real load display (see 1 B, chapter 3.3). The net load is the real load minus tackle and hook block. The button “TARE” has to be actuated before starting the lifting procedure.

The button lights up after actuation and the real load display is set to zero (tared). When the load is lifted, the real load display shows the net load (payload).

As soon as the working radius (by angle or radius modification) is modified, the display shows the real load again and the taring function is completed.

**NOTE:** The real load contains the hook block, lifting rope and all tackle. The net load is the present load on the hook without tackle. Display errors can be caused by environmental influences such as wind acting on the boom or load.

Displays and operational controls

(7) “Information” button



no function

(8) “Up” button



Use this button to increase digits or to scroll up in menus

(9) “Programming LMI” button



By using this button the function “Programming of the system according to the actual crane configuration” is activated. The procedure for setting up is described in chapter 4.



**WARNING**

The correct settings in these menus are of the utmost importance for the proper functioning of the system and the crane. The settings should therefore only be undertaken by operators who are thoroughly familiar with load capacity charts and the use and operation of the system.

Incorrect inputting can result in property damage or serious bodily injury or the death of personnel. To ensure that the LMI is properly programmed, the operating mode code and the rope reeving number (shown at data display (1)) must be verified with the help of the load capacity chart in accordance with the current configuration.

Displays and operational controls

### (10) “Anti-Two-Block” indicator light



This red warning light lights up when the anti-two-block limit switch contacts open, indicating that a two-blocking condition is imminent. In the process the audible alarm will sound.

At the same time the following crane movements are stopped: lifting, telescoping, lowering boom. In the case of cranes with derrick jib point the lowering of the point is also switched off

An anti-two-block condition occurs when the hook block comes into contact with the boom head. In this case the danger exists that the lifting rope tears and the load crashes down. The cause of an anti-two-block condition can lie in the fact that the load is being pulled against the boom head or that the boom is being telescoped or lowered without the lifting rope being slackened.

### (11) “Bypass Anti-Two-Block switch” control switch/indicator light



This control serves a dual purpose:

- The cut-off function of the Anti-Two-Block switch is bypassed during the period of activation of this switch.
- This indicator light flashes if the cut-off function of the Anti-Two-Block system has been manually bypassed.



**Since this control switch deactivates the cut-off function of the Anti-Two-Block system, it is imperative that the following instructions are complied with:**

- **The bypass control switch should only be used in emergencies, as inappropriate bypassing can result in accidents and injury to persons.**
- **Never use this bypass control switch to either overload or operate the crane outside of the permitted crane specification.**

### (12) “Audible Alarm Acknowledgement” control switch



An audible alarm message can be acknowledged by pressing this switch. The audible alarm will sound in the following instances: system testing, overload condition, malfunction of the LMI system or after recognised operating error.

Displays and operational controls

**(13) “LIM” button \***



Control switch for adjusting geometry restrictions.

The procedure is described in chapter 4.2.

*\* Function not available with all systems*

**(14) “Select rope reeving” button**



This button is used to activate the function “Direct input of the rope reeving number”.

The procedure is described in chapter 4.



**WARNING**

The correct setting up of the rope reeving is of the utmost importance for the proper functioning of the system and the crane.

**(15) “Down” button**



Use this button to decrease digits or to scroll down in menus.

**Note:** In case of a system with geometry restrictions the button lights up for programmed minimum limits and flashes for falling below a minimum limit.

**(16) “OK” button**



Use this button to confirm inputs.



## 4. CONFIGURATION SETUP

### 4.1 Setting up the system to the actual configuration

With this procedure the LMI system is adjusted in accordance with the actual crane configuration. The system is not ready for service again until the inputting and correction are complete and subsequent confirmation is made. The settings are stored. Upon switching the system on again the displayed values should be checked for conformity with the actual configuration of the crane.

The set-up procedure of the LMI to the configuration of the crane consists of at least the following steps:

- setting the operating mode code
- setting the reeving

**Depending on the type of crane and the system program further adjustments can be undertaken in the setting up menu, e.g. language selection for text displays, selecting hoisting gear etc.**

If the system is turned off, all entered values remain stored. Depending on the system program when turning the system on again, the displayed values can be acknowledged by merely pressing the “OK” button (provided that the crane configuration has not been modified).

During the setting up procedure of the operating mode and the rope reeving the “Overload Prewarning” light (3) and the “Overload” light (4) light up and the crane movements are switched off.

***Note:** If an operating mode has been selected, which has not been provided, the error code “E04” is displayed on the data display. The inputs have to be carried out again with valid inputs.*













**The correct setting up of the operating mode and rope reeving is of the utmost importance for the proper functioning of the system and the crane.  
The settings should therefore only be undertaken by operators who are thoroughly familiar with load capacity charts and the use and operation of the system.**

You will find a description of the settings in the following:









- |               |                                                                                      |
|---------------|--------------------------------------------------------------------------------------|
| Chapter 4.1.1 | Setting up the operating mode / rope reeving (for systems <b>with</b> text menus)    |
| Chapter 4.1.2 | Setting up the operating mode / rope reeving (for systems <b>without</b> text menus) |
| Chapter 4.1.3 | Setting up the rope reeving (quick setting up for systems <b>with</b> text menus)    |
| Chapter 4.1.4 | Setting up the rope reeving (quick setting up for systems <b>without</b> text menus) |

## Configuration Setup

**4.1.1 Setting up the operating mode / rope reeving (for systems with text menus)**









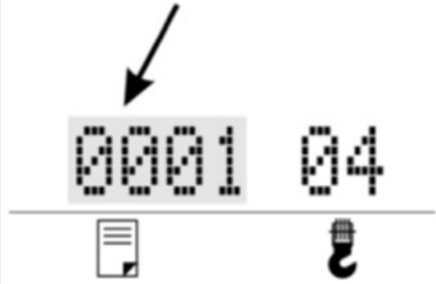

Input	Display (examples)	Comments
	DRUECKE "OK" FUER DEUTSCH ... PUSH "OK" FOR ENGLISH ...	The menu begins with the setting of the language for text displays. The following languages are available: <i>English, German, French, Spanish</i> To select the desired language press button  or  and confirm with button  . . All further text displays will be made in the selected language.
	ENTER OP. MODE CODE OP. MODE CODE 0101 OP. MODE CODE 0101	Now enter the operating mode code in accordance with the load capacity charts: <i>Tip: If no change of the displayed code is necessary because the crane configuration has not been changed the displayed code can be confirmed by pressing the OK button a little longer.</i> Flashing digits can be changed with button  or  . <i>Tip: Quick change by pressing the appropriate button a little longer.</i> The next digit is selected with the  button. After inputting the last digit and pressing the  button the data of the selected operating mode code is displayed.
	CODE 0101:MAIN BOOM -ON OUTRIGGERS -OVER FRONT -W/O PPF PUSH "OK"	Confirm with button  , or if necessary with button  to return to the previous menu. >>>

## Configuration Setup

Input	Display (examples)	Comments
	ARE OUTRIGGERS PROPERLY POSITIONED?  IF YES PUSH "OK"	<ul style="list-style-type: none"> <li><b>in case of operating modes with condition "supported":</b></li> </ul> Please check whether the outriggers were correctly extended and have secure contact with the ground in accordance with the selected operating mode!  If OK, confirm with the  button.
	AXLE LOCKOUT/SUS- PENSION FUNKTIONING? (IF APPLICABLE)  IF YES PUSH "OK"	<ul style="list-style-type: none"> <li><b>in case of operating modes with condition "free / on wheels":</b></li> </ul> Please check whether the axle locking was correctly carried out!  If OK, confirm with the  button.
	IS CRANE LEVEL ON A FIRM SUPPORTING SURFACE?  IF YES PUSH "OK"	Please check whether the crane is straight and aligned on ground capable of bearing the crane!  If OK, confirm with the  button.
	SELECT DESIRED HOIST:  FOR MAIN PUSH ↑ FOR AUX PUSH ↓	For cranes with additional hoisting gear it is necessary in this menu to indicate the hoisting gear used  indicate the hoisting gear used with button  or 
	ENTER REEVING:  05 FALLS	Select the actual number of lifting rope reevings with button  or   and then confirm with button  .  <i><b>NOTE:</b> If an operating mode was selected, which is not available, the error code E04 is displayed. In this case the inputs should be repeated with valid values.</i>  This concludes the setting up of the system to the actual crane configuration, the system is ready for service and the LMI menu picture is displayed.





## Configuration Setup

**4.1.2 Setting up the operating mode (for systems without text menus)**





Input	Display (examples)	Comments
		<p>After pressing the  button the first digit of the operating mode code flashes.</p> <p>Flashing digits can be changed with button  or .</p> <p><i>Tip: Quick change by pressing the appropriate button a little longer.</i></p> <p>The next digit is selected in each case with the  button.</p> <p>After selection of or change of the last digit the input is concluded by pressing the  button again</p> <p><b>NOTE:</b> If an operating mode was selected, which is not available, the error code E04 is displayed. In this case the inputs should be repeated with valid values.</p> <p><b>To setup the system to the actual crane configuration the inputting of the rope reeving number is necessary:</b></p>
		<p>Select the actual number of lifting rope reevings with button  or </p> <p>and then confirm with button .</p> <p>This concludes the setting up of the system to the actual crane configuration, the system is ready for service and the LMI menu picture is displayed.</p>

## Configuration Setup

**4.1.3. Setting up the rope reeving  
(quick setting up for systems with text menus)**

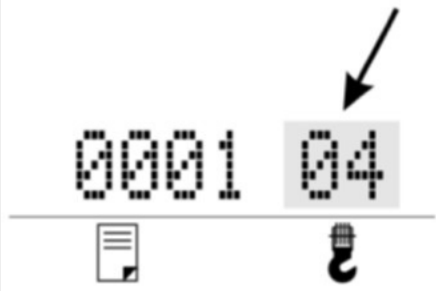
Input	Display (examples)	Comments
	<p data-bbox="518 512 802 541">ENTER REEVING:</p> <p data-bbox="518 564 764 594">05 FALLS</p>	<p data-bbox="1008 512 1463 594">Select the actual number of lifting rope reevings with button  or </p> <p data-bbox="1008 659 1520 730"><b>NOTE:</b> During inputting of the rope reeving number, the indicator lamps light up to indicate prewarning and overload and the crane movements are stopped.</p> <p data-bbox="1008 764 1406 804">Confirmation with the  button</p> <p data-bbox="1008 873 1520 961">This concludes the setting up of the system to the actual reeving condition of the crane and the LMI menu picture is displayed.</p>

**4.1.4. Setting up the rope reeving  
(quick setting up for systems without text menus)**

Input	Display (examples)	Comments
		<p data-bbox="1008 1289 1463 1371">Select the actual number of lifting rope reevings with button  or </p> <p data-bbox="1008 1436 1520 1507"><b>NOTE:</b> During inputting of the rope reeving number, the indicator lamps light up to indicate prewarning and overload and the crane movements are stopped.</p> <p data-bbox="1008 1541 1365 1581">Confirmation with button .</p> <p data-bbox="1008 1650 1520 1738">This concludes the setting up of the system to the actual reeving condition of the crane and the LMI menu picture is displayed.</p>

## 4.2. Geometry restrictions



The function described in the following “Geometry restrictions” represents an aid to moving the crane within adjustable boom ranges.

The reaching or exceeding of programmed limits

**does not trigger a switching off of the crane movement!**

**The crane operator has sole responsibility for the safe operation of the crane!**

- **Depending on the type of crane and the available system program** the LMI system has programmable functions for geometry restriction according to the operative range of the crane.

The following restrictions are available:





HEIGHT LIMIT	-	restriction of the boom head height	> see Chapter 4.2.1
ANGLE LIMIT	-	restriction of the boom angle	> see Chapter 4.2.2
RADIUS LIMIT	-	restriction of the boom radius	> see Chapter 4.2.3

- The programming is made easier by interactive step-by-step guidance.
- The functions can be used separately or in combination.
- The exceeding of a programmed limit triggers an audible alarm and a visible message (button for exceeding / falling below flashes).
- The programmed limits are clearly laid out in an informational menu picture: >>>









## Configuration Setup

**Display of programmed limits**





Input	Display (examples)	Comments												
	<table border="0"> <tr> <td></td> <td style="text-align: center;">MAX</td> <td style="text-align: center;">MIN</td> </tr> <tr> <td>HEIGHT</td> <td style="text-align: center;">14.8</td> <td></td> </tr> <tr> <td>ANGLE</td> <td></td> <td></td> </tr> <tr> <td>RADIUS</td> <td style="text-align: center;">8.0</td> <td style="text-align: center;">5.0</td> </tr> </table>		MAX	MIN	HEIGHT	14.8		ANGLE			RADIUS	8.0	5.0	After operating the control switch once the <b>information picture</b> is displayed, in which all of the programmed limits are shown. <i>(In the adjacent <b>example</b> limits are set for height restriction and minimum and maximum radius.)</i>
	MAX	MIN												
HEIGHT	14.8													
ANGLE														
RADIUS	8.0	5.0												
	 <p>HEIGHT LIMIT</p> <p>ANGLE LIMIT</p> <p>RADIUS LIMIT</p> <p>BACK</p>	<p>To <b>close</b> the information picture: press the  button.</p> <p>or:</p> <p>For the <b>programming</b> of limits: operate the  button again.</p> <p>The procedure is described in the following chapters:</p>												

## Configuration Setup

**4.2.1 Restricting the maximum boom head height (example)**







Input	Display (examples)	Comments
	MAX    MIN HEIGHT ANGLE RADIUS	After operating the control switch once the <b>information picture</b> is displayed, in which all of the programmed limits are shown. <i>(In the adjacent <b>example</b> no limits have been set yet.)</i>
	HEIGHT LIMIT ANGLE LIMIT RADIUS LIMIT BACK	After operating the control switch again the programming mode commences: Line 1: "HEIGHT LIMIT" flashes if not: use the button  or  to select "HEIGHT LIMIT". The selected line flashes. Then press the  button to confirm.
	MAX TIP HEIGHT 15.9 STATE: DISABLED	Display the present height. Now move the boom to the desired maximum value!
		Press the  button for programming of the displayed value as the maximum height. The button lights up and the condition is displayed as "Enabled".
	MAX TIP HEIGHT 15.9 STATE: ENABLED	<i><b>Note:</b> Repeated pressing of the control switch switches the restriction on/off.</i> Confirm programming with the  button.
	HEIGHT LIMIT ANGLE LIMIT RADIUS LIMIT BACK	The selection menu appears again. Additional restrictions can now be programmed.  <i>or : &gt;&gt;&gt;</i>

## Configuration Setup





Input	Display (examples)	Comments												
	HEIGHT LIMIT ANGLE LIMIT RADIUS LIMIT BACK	Close the programming: use the button  or  to select "RETURN".  <i>TIP: if line 1 "HEIGHT LIMIT" flashes, the cursor will jump directly to line 4 "BACK" by pressing the button "up" once.</i>  Close the programming by pressing the  button.  The display now shows the normal LMI picture.												
	<table border="0"> <tr> <td></td> <td style="text-align: center;">MAX</td> <td style="text-align: center;">MIN</td> </tr> <tr> <td>HEIGHT</td> <td style="text-align: center;">15.9</td> <td></td> </tr> <tr> <td>ANGLE</td> <td></td> <td></td> </tr> <tr> <td>RADIUS</td> <td></td> <td></td> </tr> </table>		MAX	MIN	HEIGHT	15.9		ANGLE			RADIUS			Information about limits already programmed: By pressing the "LIM" button once. Close the information picture by pressing the  button.
	MAX	MIN												
HEIGHT	15.9													
ANGLE														
RADIUS														

## Configuration Setup

**4.2.2 Restricting the boom angle (example: maximum boom angle)**







Input	Display (examples)	Comments
	MAX    MIN HHEIGHT ANGLE RADIUS	After operating the control switch once the <b>information picture</b> is displayed, in which all of the programmed limits are shown. <i>(In the adjacent <b>example</b> no limits have been set yet.)</i>
	HEIGHT LIMIT ANGLE LIMIT RADIUS LIMIT BACK	After operating the control switch again the programming mode commences:  Press button  until "ANGLE LIMIT" flashes.  Press the  button to confirm.
	MAX ANGLE MIN ANGLE BACK	Select the desired boom angle restriction. (in this case max. angle)  <i>NOTE: In the following example only the programming of the maximum boom angle is described. The programming of the minimum boom angle is carried out by now selecting "MIN ANGLE".</i>  Press the  button to confirm.
	MAX ANGLE 61.5 STATE: DISABLED  MAX ANGLE 61.5 STATE: ENABLED	Now move the boom to the desired boom angle!   Press the  button for programming of the displayed value as the maximum angle. The button lights up and the condition is displayed as "ENABLED".
		<i>Note: Repeated pressing of the control switch switches the restriction on/off.</i>  Confirm the programming with the  button.  >>>

## Configuration Setup

Input	Display (examples)	Comments												
	HOE IGH T L I M I T ANGLE L I M I T R A D I U S L I M I T B A C K	The selection menu appears again. Additional restrictions can now be programmed.  or :												
	H E I G H T L I M I T ANGLE L I M I T R A D I U S L I M I T B A C K	Close the programming: use the button  or  to select "RETURN".  <i>TIP: if line 1 "HEIGHT LIMIT" flashes, the cursor will jump directly to line 4 "BACK" by pressing the button "up" once.</i>  Close the programming by pressing the  button.  <b>The display now shows the normal LMI picture.</b>												
	<table border="0"> <tr> <td></td> <td>MAX</td> <td>MIN</td> </tr> <tr> <td>HEIGHT</td> <td>15.9</td> <td></td> </tr> <tr> <td>ANGLE</td> <td>61.5</td> <td></td> </tr> <tr> <td>RADIUS</td> <td></td> <td></td> </tr> </table>		MAX	MIN	HEIGHT	15.9		ANGLE	61.5		RADIUS			Information about limits already programmed: By pressing the "LIM" button once. Close the information picture by pressing the  button.
	MAX	MIN												
HEIGHT	15.9													
ANGLE	61.5													
RADIUS														





## Configuration Setup

**4.2.3 Restricting the boom radius (example: maximum boom radius)**

Input	Display (examples)	Comments
	MAX    MIN HEIGHT ANGLE RADIUS	After operating the control switch once the <b>information picture</b> is displayed, in which all of the programmed limits are shown. <i>(In the adjacent <b>example</b> no limits have been set yet.)</i>
	HEIGHT LIMIT ANGLE LIMIT <b>RADIUS LIMIT</b> BACK	After operating the control switch again the programming mode commences:  Press button  repeatedly until "RADIUS LIMIT" flashes.  Press the  button to confirm.
	MAX RADIUS MIN RADIUS BACK	Select the desired boom radius restriction. (in this case max. radius)  <i>NOTE: In the following example only the programming of the maximum boom radius is described. The programming of the minimum boom radius is carried out by now selecting "MIN RADIUS".</i>  Press the  button to confirm.
	MAX RADIUS 13.1 STATE: DISABLED  MAX RADIUS 13.1 STATE: ENABLED	Now move the boom to the desired boom radius !   Press the  button for programming of the displayed value as the maximum radius. The button lights up and the condition is displayed as "ENABLED".
		<i>Note: Repeated pressing of the control switch switches the restriction on/off.</i>  Confirm the programming with the  button.  <div style="text-align: right;">&gt;&gt;&gt;</div>



## Configuration Setup

Input	Display (examples)	Comments												
	HEIGHT LIMIT ANGLE LIMIT RADIUS LIMIT BACK	The selection menu appears again. Additional restrictions can now be programmed.  or :												
	HEIGHT LIMIT ANGLE LIMIT RADIUS LIMIT BACKK	Close the programming: use the button  or  to select "BACK".  <i>TIP: if line 1 "HEIGHT LIMIT" flashes, the cursor will jump directly to line 4 "BACK" by pressing the button "up" once.</i>  Close the programming by pressing the  button.  <b>The display now shows the normal LMI picture.</b>												
	<table border="1"> <thead> <tr> <th></th> <th>MAX</th> <th>MIN</th> </tr> </thead> <tbody> <tr> <td>HEIGHT</td> <td>15.9</td> <td></td> </tr> <tr> <td>ANGLE</td> <td>61.5</td> <td></td> </tr> <tr> <td>RADIUS</td> <td>13.1</td> <td></td> </tr> </tbody> </table>		MAX	MIN	HEIGHT	15.9		ANGLE	61.5		RADIUS	13.1		Information about limits already programmed: By pressing the "LIM" button once. Close the information picture by pressing the  button.
	MAX	MIN												
HEIGHT	15.9													
ANGLE	61.5													
RADIUS	13.1													

## 5. PRE-OPERATION INSPECTION

Before operating the crane, the following electrical connections must be checked to ensure that the LMI system is properly connected for the crane configurations.

If the crane works only with the main boom, that is without boom extension or jib, check that the bypass plug(s) are pushed in and the weight on the anti two-block switch (-es) is properly installed on the main boom hoist load line(s). With an even number of hoisting lines, the weight on the anti two-block switch (-es) is to be attached to the dead-end line of the lifting rope. With an odd number of hoisting lines, the weight on the anti two-block switch (-es) is to be attached to the line with the lowest working speed.

If the crane works with a main boom extension or jib, the connecting cable must be installed between the junction box on the boom jib and the main boom junction box. The weight attached to the main boom anti two-block switch must be unhitched.

If the anti two-block switch weight is not repositioned the anti two-block switch system cannot function properly. No weight should be installed on the main boom anti two-block switch when the boom extension/jib is being used.

After the electrical connections have been checked for the respective configuration, the following checks must be made in addition:

1. Check the electrical wiring connecting the various parts of the system for physical damage
2. Check the anti two-block switches and weights for free movement
3. Check the spring-loaded cable reel to be sure it is free to rotate, has tension and the cable is reeled properly.

The following tests must be performed with care to prevent damage to the crane or injury to personnel. The proper functioning of the LMI system requires successful completion of these tests before operating the machine.

If the crane operator cannot see the hook block approaching the boom nose, he must have an assistant (signal person) to watch. The crane operator must be prepared to stop the machine immediately should the LMI system not function properly, i.e. if the red warning light does not light up, the audible alarm does not sound and crane movements such as lifting, telescoping and boom down are not switched off.

4. Check the anti two-block alarm light and the audible alarm by performing one of the following tests:
  - a) Manually lift the weight attached to the anti two-block switches. As soon as the weight is lifted, the audible alarm should sound and the anti two-block alarm light (2) should light up.
  - b) Slowly raise the hook block with the main hoisting gear against the anti two-block switch weight. As soon as the hook block lifts the weight, the audible alarm should sound, the anti two-block alarm light (2) should light up and the main hoisting gear should be switched off. Lower the hook block slightly to eliminate this condition.
  - c) Slowly lower the main boom to induce a possible A2B condition. As soon as the hook block lifts the weight, the audible alarm should sound, the anti two-block alarm light should light up and the jib gear should be switched off. Lower the hook block slightly to eliminate this condition.

## Pre-Operation Inspection / Service / Maintenance

If the warning light and audible alarm do not function as described and the crane movements are not stopped, the system is not working properly. The malfunction must be corrected before operating the crane.

5. If the crane is equipped with a boom extension or boom jib, the test procedure for the boom extension/jib anti two-block switch (-es) must be repeated.
6. Check that the main boom angle as displayed agrees with the actual angle.
7. Check that the working radius of the crane as displayed agrees with the actual working radius.
8. Check the load display by lifting a load of known weight.

### 5.1 Operation

Following correct setting up the LMI is ready for service. The crane operator must therefore be thoroughly familiar with all operational controls of the LMI and input the correct details before operating the crane. All settings must be checked by lifting a load of known weight and comparing the load to the information displayed on the LMI.

The values of the load capacity chart include the weight of the hook block, sling ropes and auxiliary load handling devices. Their combined weights must be subtracted from the values of the load capacity chart to determine the net load to be lifted.



#### **WARNING**

**If any of the displays reflect a deviation between displayed and actual values an authorised PAT service representative should be called for re-verification of the crane's LMI calibration or repair of the system.**



#### **WARNING**

**Any structural modifications or changes to the crane require re-verification and/or correction of the LMI calibration of your crane.**

## 6. SERVICE AND MAINTENANCE

Daily maintenance of the Load Moment Indicator system consists of inspecting:

1. The electrical wiring connecting the various parts of the system. If a cable is damaged, it should be replaced immediately.
2. If the insulation is worn on the electrical wiring or cable guides are damaged, these parts should be replaced.
3. Check the anti two-block limit switches for freedom of movement.

**Personnel who have not been specially trained should only eliminate the malfunctions identified in the error table but should not, however, replace any defective mechanical or electronic parts and cables.**

When the LMI system is turned on, it will first of all commence an internal system test. During this time, the data display shows the following screen:

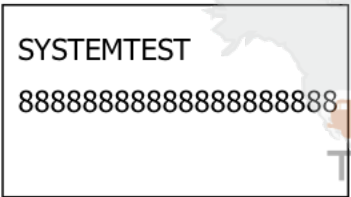

```
SYSTEMTEST  
888888888888888888888888
```

During this test check that the display is working, the lights light up and the audible alarm sounds.

If the system does not start as described please contact your nearest PAT service representative before operating the crane!

Troubleshooting

## 7. TROUBLESHOOTING

### 7.1 General information

In case of a malfunction or an operating error recognised by the system, the data display (1) indicates a code “E##” which states the reason for the malfunction.

The error codes listed in the error table explain the various faults, which can occur with the Load Moment Indicator.

Faults within the microprocessor system should only be repaired by trained service personnel of the manufacturer. In such an instance please contact the PAT customer service.

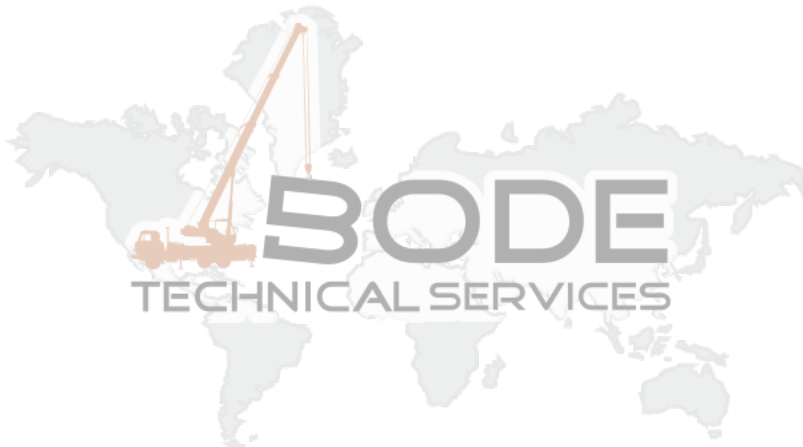

Error Code Table

**7.2 Fault notifications**

**Error code table**

System program: G53T V 2.0 (6.12.2004)

Software No. 71 050 00 0154



<b>Error Code</b>	<b>Error</b>	<b>Cause</b>	<b>Remedy</b>
<b>E01</b>	Fallen below radius range or angle range exceeded	<ul style="list-style-type: none"> <li>fallen below the minimum radius or gone past the maximum angle specified in the respective load chart due to luffing up the boom too far</li> </ul>	<ul style="list-style-type: none"> <li>luff up the boom to a radius or angle specified in the load chart</li> </ul>
<b>E02</b>	Radius range exceeded or fallen below angle range	<ul style="list-style-type: none"> <li>gone past the maximum radius or fallen below the minimum angle specified in the respective load chart due to luffing up the boom too far</li> </ul>	<ul style="list-style-type: none"> <li>luff down the boom to a radius or angle specified in the load chart</li> </ul>
<b>E04</b>	Operating mode not acknowledged or non permitted slewing zone	<ul style="list-style-type: none"> <li>A non existing operating mode has been selected</li> <li>The boom is in a non-permitted slewing zone</li> </ul>	<ul style="list-style-type: none"> <li>Set the correct operating mode for the operating state in question</li> <li>Slew the boom to a permitted area.</li> </ul>



Error Code Table

Error Code	Error	Cause	Remedy
<b>E05</b>	Forbidden length range of the main boom	<ul style="list-style-type: none"> <li>• Boom has been extended too far or not enough, e.g. if operation is only admitted up to a certain boom length or for load charts of jibs with the boom having to be extended to a certain length.</li> <li>• The length sensor adjustment was modified, e.g. rope slid off the length sensor reel.</li> <li>• Clutch between length sensor pot and drive is defective</li> <li>• Failure of the +5V-supply for the analog part of the LMI-analog board.</li> <li>• Length potentiometer defective.</li> </ul>	<ul style="list-style-type: none"> <li>• Retract or extend boom to the correct length.</li> <li>• Retract the boom. Check the prestress of the cable reel (the rope has to be under traction). Open the length sensor and carefully turn the length pot counterclockwise to the detent by use of a screwdriver.</li> <li>• Completely replace the clutch with the drive wheel and adjust length sensor pot</li> <li>• Check +5V-voltage. If there is no voltage or break down at a charge of 50 ohm approximately, exchange LMI board.</li> <li>• Replace length potentiometer.</li> </ul>
<b>E07</b>	<p>Faulty acknowledgment by the overload relay of the LMI board.</p> <p>Relay should be energized but 2nd contact is indicated off, or the 2nd contact is indicated on while the relay should be deenergized.</p>	<ul style="list-style-type: none"> <li>• Overload relay defective</li> <li>• LMI board defective</li> </ul>	<ul style="list-style-type: none"> <li>• Replace relay</li> <li>• Replace LMI board</li> </ul>
<b>E08</b>	No acknowledgement of the anti-two-block switch relay.	<ul style="list-style-type: none"> <li>• cf. error E07</li> </ul>	<ul style="list-style-type: none"> <li>• cf. error E07</li> </ul>
<b>E11</b>	Fallen below limit for the measuring channel "Length main boom".	<ul style="list-style-type: none"> <li>• Length sensor pot defective</li> <li>• Electronic board in the measuring channel defective.</li> </ul>	<ul style="list-style-type: none"> <li>• Replace length sensor potentiometer.</li> <li>• Replace LMI board.</li> </ul>

Error Code Table

Error Code	Error	Cause	Remedy
<b>E12</b>	Fallen below the lower limit value in the measuring channel "pressure piston side"	<ul style="list-style-type: none"> <li>• Cable between the central unit and sensor defective or water inside the plugs</li> <li>• Sensor is defective.</li> <li>• Electronic component in the measuring channel is defective.</li> </ul>	<ul style="list-style-type: none"> <li>• Check cable as well as plugs, replace, if need be.</li> <li>• Replace sensor</li> <li>• Replace LMI main board or processor board.</li> </ul>
<b>E13</b>	Fallen below lower limit value in the measuring channel "pressure rod side" or "Force2"	<ul style="list-style-type: none"> <li>• refer to E12</li> </ul>	<ul style="list-style-type: none"> <li>• refer to E12</li> </ul>
<b>E14</b>	Fallen below lower limit value in the measuring channel "Force 1"	<ul style="list-style-type: none"> <li>• refer to E12</li> </ul>	<ul style="list-style-type: none"> <li>• refer to E12</li> </ul>
<b>E15</b>	Fallen below lower limit value for the measuring channel "angle main boom".	<ul style="list-style-type: none"> <li>• Angle sensor defective.</li> <li>• Electronic part in the measuring channel defective.</li> </ul>	<ul style="list-style-type: none"> <li>• Replace angle sensor.</li> <li>• Replace LMI board.</li> </ul>
<b>E16</b>	Fallen below lower limit value in the measuring channel "Angle 2"	<ul style="list-style-type: none"> <li>• refer to E15</li> </ul>	<ul style="list-style-type: none"> <li>• refer to E15</li> </ul>
<b>E17</b>	Fallen below lower limit value in the measuring channel "Length 2"	<ul style="list-style-type: none"> <li>• refer to E12</li> </ul>	<ul style="list-style-type: none"> <li>• refer to E12</li> </ul>
<b>E19</b>	Reference and/or supply voltage defective	<ul style="list-style-type: none"> <li>• The supply voltage is falsified by one of the sensors (DAV, LWG)</li> <li>• Electronic component is defective</li> <li>• A/D converter of CPU 80C517 defective.</li> </ul>	<ul style="list-style-type: none"> <li>• Check the voltages on the LMI main board (AGND = MP0). Check sensors, plugs and cable, replace, if need be.</li> <li>• Replace LMI board</li> <li>• Replace LMI board</li> </ul>
<b>E21</b>	Upper limit value for measuring channel "length main boom" exceeded.	<ul style="list-style-type: none"> <li>• Length sensor pot defective.</li> <li>• Electronic part in the measuring channel defective.</li> </ul>	<ul style="list-style-type: none"> <li>• Replace length sensor potentiometer.</li> <li>• Replace LMI board.</li> </ul>
<b>E22</b>	Upper limit value in measuring channel "pressure piston side" has been exceeded	<ul style="list-style-type: none"> <li>• refer to E12</li> </ul>	<ul style="list-style-type: none"> <li>• refer to E12</li> </ul>

Error Code Table

Error Code	Error	Cause	Remedy
<b>E23</b>	Upper limit value in measuring channel "pressure rod side" or "Force 2" has been exceeded.	<ul style="list-style-type: none"> <li>refer to E12</li> </ul>	<ul style="list-style-type: none"> <li>refer to E12</li> </ul>
<b>E24</b>	Upper limit value in measuring channel "Force 1" has been exceeded	<ul style="list-style-type: none"> <li>refer to E12</li> </ul>	<ul style="list-style-type: none"> <li>refer to E12</li> </ul>
<b>E25</b>	Upper limit value in measuring channel "angle main boom" exceeded	<ul style="list-style-type: none"> <li>refer to E15</li> </ul>	<ul style="list-style-type: none"> <li>refer to E15</li> </ul>
<b>E26</b>	Upper limit value in measuring channel "angle 2" has been exceeded.	<ul style="list-style-type: none"> <li>refer to E15</li> </ul>	<ul style="list-style-type: none"> <li>refer to E15</li> </ul>
<b>E27</b>	Upper limit value in measuring channel "Length 2" has been exceeded.	<ul style="list-style-type: none"> <li>refer to E12</li> </ul>	<ul style="list-style-type: none"> <li>refer to E12</li> </ul>
<b>E29</b>	Reference and/or supply voltage defective	<ul style="list-style-type: none"> <li>refer to E19</li> </ul>	<ul style="list-style-type: none"> <li>refer to E19</li> </ul>
<b>E31</b>	Error in the system program	<ul style="list-style-type: none"> <li>The system program PROM is defective.</li> </ul>	<ul style="list-style-type: none"> <li>Replace system program PROM (PROM No. 0)</li> </ul>
<b>E37</b>	Error in the logic program course	<ul style="list-style-type: none"> <li>The system program PROM is defective</li> <li>Computer module 80C517 defective</li> <li>LMI board defective</li> </ul>	<ul style="list-style-type: none"> <li>Replace system program PROM (PROM No. 0)</li> <li>Replace computer module 80C517</li> <li>Replace LMI board</li> </ul>
<b>E38</b>	System program and data EPROM do not match.	<ul style="list-style-type: none"> <li>The system program in the LMI does not match to the programming in the data EPROM</li> </ul>	<ul style="list-style-type: none"> <li>Replace the system program PROM or the data EPROM (PROM No. 1)</li> </ul>
<b>E41</b>	Error in the internal write/read memory (RAM) of the computer component 80C517	<ul style="list-style-type: none"> <li>Computer component 80C517 defective</li> <li>CPU module defective</li> <li>LMI board defective.</li> </ul>	<ul style="list-style-type: none"> <li>Replace computer component 80C517.</li> <li>Replace CPU module.</li> <li>Replace LMI board with CPU module</li> </ul>
<b>E42</b>	Error in the external write/read memory, 1st part (RAM)	<ul style="list-style-type: none"> <li>Write/read memory (CMOS RAM) or LMI board defective</li> </ul>	<ul style="list-style-type: none"> <li>Replace LMI board</li> </ul>
<b>E43</b>	Error in the external write/read memory, 2nd part (RAM)	<ul style="list-style-type: none"> <li>refer to E42</li> </ul>	<ul style="list-style-type: none"> <li>refer to E42</li> </ul>

Error Code Table

Error Code	Error	Cause	Remedy
<b>E48</b>	Cyclic RAM test: error in the internal write/read memory (RAM) of the computer component 80C517	<ul style="list-style-type: none"> <li>• Computer component 80C517 defective</li> <li>• LMI board defective</li> </ul>	<ul style="list-style-type: none"> <li>• Replace computer component 80C517</li> <li>• Replace LMI board</li> </ul>
<b>E51</b>	Error in the crane data EPROM or EEPROM.	<ul style="list-style-type: none"> <li>• No valid data in the crane data EEPROM</li> <li>• Memory module wrongly bridged</li> <li>• Crane data EPROM defective</li> </ul>	<ul style="list-style-type: none"> <li>• Load crane data EEPROM containing valid data.</li> <li>• Bridge memory module acc. to memory type</li> <li>• Replace crane data EPROM</li> </ul>
<b>E55</b>	Wrong central unit used	<ul style="list-style-type: none"> <li>• The used central unit (board 24 050 30 0030) is a standard-board and not a retrofit-board</li> </ul>	<ul style="list-style-type: none"> <li>• replace board with a retrofit-board</li> </ul>
<b>E56</b>	Error in crane data EEPROM.	<ul style="list-style-type: none"> <li>• Memory module wrongly bridged.</li> <li>• Crane data EEPROM defective</li> </ul>	<ul style="list-style-type: none"> <li>• Bridge memory module acc. to memory type</li> <li>• Replace crane data EEPROM</li> </ul>
<b>E57</b>	Error in serial crane data EEPROM.	<ul style="list-style-type: none"> <li>• Serial crane data EEPROM does not contain valid data.</li> <li>• Memory module defective</li> </ul>	<ul style="list-style-type: none"> <li>• Write data on the serial crane data EEPROM (by means of test program or on-line function), then restart the LMI</li> <li>• Replace memory module.</li> </ul>
<b>E58</b>	Error in the serial analog data EEPROM.	<ul style="list-style-type: none"> <li>• No valid data in the serial analog data EEPROM.</li> <li>• LMI main board defective.</li> </ul>	<ul style="list-style-type: none"> <li>• Write data on the serial analog data EEPROM by means of the test program, then, restart the LMI</li> <li>• Replace LMI main board.</li> </ul>
<b>E78</b>	Short circuit in the A2B switch circuit	<ul style="list-style-type: none"> <li>• Short circuit in the A2B switch</li> <li>• Short circuit in the cable to the A2B switch</li> </ul>	<ul style="list-style-type: none"> <li>• Replace A2B switch</li> <li>• Replace cable to the A2B switch</li> </ul>
<b>E91</b>	No data transmission from the console to the central unit	<ul style="list-style-type: none"> <li>• 24 V supply of the console is interrupted</li> <li>• Interruption or accidental ground in the line between console electronics and central unit</li> <li>• Transmitter/receiver module in console or central unit is defective</li> </ul>	<ul style="list-style-type: none"> <li>• Check 24 V at terminal X1 of the console electronics</li> <li>• Check the connection console electronics - central unit. In case of an accidental ground, the transmitter module of the console electronics might be damaged. Therefore, replaces the console electronics.</li> <li>• Exchange console electronics or LMI main board resp.</li> </ul>

Error Code Table

Error Code	Error	Cause	Remedy
<b>E92</b>	Error in the data transmission from console to central unit	<ul style="list-style-type: none"> <li>Loose connection in the line between console electronics and central unit</li> <li>Transmitter/receiver module is defective</li> </ul>	<ul style="list-style-type: none"> <li>Check the connection between console electronics and central unit</li> <li>Exchange console electronics or LMI main board resp.</li> </ul>
<b>E93</b>	Error in the data transmission from the central unit to the console	<ul style="list-style-type: none"> <li>refer to E92</li> </ul>	<ul style="list-style-type: none"> <li>refer to E92</li> </ul>
<b>E94</b>	No data transmission from the central unit to the console	<ul style="list-style-type: none"> <li>Interruption or accidental ground in the line central unit – console</li> <li>5 V supply of the computer in the central unit is missing</li> <li>5 V supply is too low</li> <li>Transmitter/receiver module is defective</li> <li>Computer module is defective</li> <li>Electro-magnetic interferences (e.g. when switching contactors or valves)</li> </ul>	<ul style="list-style-type: none"> <li>Check line to the console (in case of accidental ground, replace console electronics, too)</li> <li>Check connection to the power unit</li> <li>Exchange the LMI main board</li> <li>Replace console electronics or LMI main board</li> <li>Replace processor board</li> <li>Eliminate the source of interferences by inverse diodes or varistors</li> </ul>
<b>E95</b>	Error in the console EPROM	<ul style="list-style-type: none"> <li>The console EPROM is defective</li> </ul>	<ul style="list-style-type: none"> <li>Replace the console EPROM</li> </ul>
<b>E96</b>	Error in the internal RAM of the console.	<ul style="list-style-type: none"> <li>The CPU of the console is defective</li> <li>The console main board is defective</li> </ul>	<ul style="list-style-type: none"> <li>Replace the CPU of the console</li> <li>Replace the console main board</li> </ul>

**Remark**

If an error message is displayed that does not figure in this list, please contact the competent PAT service department as soon as possible.



Appendix: Important information for crane operators and users

## **CODE OF PRACTICE 1 Cut-off values for boom cranes with variable capacity depending on variable working radius**

We calculate the crane cut-off values on the basis of the load capacity charts and construction drawings of the crane manufacturers.

These theoretical cut-off values must be checked by testing the crane with weighed test loads in all operating modes and at least in the following configurations depending on the crane type.

- **Cranes with fixed boom length during operation:**  
Minimum, medium and maximum radius with shortest, medium and longest boom length as well as with shortest, medium and longest boom jib length with these boom lengths.
- **Cranes with variable boom length during operation:**  
Minimum, medium and maximum radius at each length step as well as with all boom jibs.

## **CODE OF PRACTICE 2 Important information for the crane operator**

The LMI is an operational aid, which warns a crane operator of imminent overload conditions and also warns of the hook block approaching the boom head to prevent damage to equipment and personnel.

The device is not, and is not intended to be a substitute for good operator judgment, experience and use of accepted safe crane operating procedures. The responsibility for the safe operation of the crane shall remain with the crane operator who shall ensure that all warnings and instructions supplied are fully understood and observed. Prior to operating the crane, the operator must carefully and thoroughly read and understand the manual to ensure that he knows the operation of the LMI and the crane. Proper functioning is dependent upon proper daily inspection of the system and observance of the operating instructions set forth in this manual.

The system can only assist the crane operator, if the LMI has been properly setup and the correct load capacity chart and correct operating mode number have been input for the respective configuration. To prevent material damage and serious or even fatal injuries to staff, the correct adjustment of the LMI has to be ensured before starting the crane operation.



**This system can be equipped with a device (key-operated switch / control switch) which is manually operated and which overrides the cut-off function of the LMI or the anti two-block switch system. The key-operated switch or control switch must only be activated in emergencies and by authorised staff. Failure to comply with this instruction can result in material damage and serious or even fatal injuries to staff.**



### CODE OF PRACTICE 3 Important information for crane users

In the Federal Republic of Germany, the code of practice of the Association of German Engineers VDI (Verein Deutscher Ingenieure) 3570 is effective for the construction of rated capacity limiters. Reference is also made there to the purpose and the limits of the rated capacity limiter.

“Rated capacity limiters are to prevent as far as possible accidents, the endangering of persons, objects, the load and the crane as a result of an overload situation during the operation of the crane. Users and crane operators must take into account that a rated capacity limiter cannot register all hazards in good time and that a malfunction due to non-identifiable influences is possible. They are therefore not relieved of the necessity for prudence and the responsibility for the observance of the operating instructions and the load of the crane. Rated capacity limiters are not intended for regular operation. They are only to respond in emergency situations. The capacity of the hoisting equipment is not to be reduced by a rated capacity limiter.”

#### VDMA code of practice for rated capacity limiters (load moment limiting devices) on boom cranes

The boom crane delivered to you is equipped with a rated capacity limiter (overload cut-off device) according to §24 of the accident prevention regulation UVV “boom cranes” which will switch off the hoisting gear and boom hoist unit of the crane when exceeding the admissible safe load. It must remain possible to carry out the opposite movement in order to be able to relieve the crane of the load after the rated capacity limiter has reacted, e.g. it must be possible to lower the load after the hoisting gear has been switched off.

The installation of a rated capacity limiter (overload cut-off device) is intended to prevent the crane from lifting a load, which would endanger its stability. In other words the rated capacity limiter (overload cut-off device) is an emergency switch which, in the event of a crane overload situation, switches off all movements increasing the load moment thus preventing a case of possible damage or accident. The following must be observed for the rated capacity limiter to fulfil its function as a safety device:

1. Rated capacity limiters (overload cut-off devices) must not be used operationally to switch off the hoisting gear or boom hoist unit. The crane operator must in any case previously make sure that the load to be lifted will not exceed the lifting capacity of the crane. Excessively heavy loads exceeding the lifting capacity of the crane must not be lifted even with a rated capacity limiter installed. Rated capacity limiters must under no circumstances be used as scales and the crane must not be loaded beyond the respectively admissible load.
2. Freeing loads, which are stuck, must only be undertaken after consultation with the crane manufacturer and with cranes especially equipped for this purpose. During these operations the rated capacity limiter (overload cut-off device) must not be used as an operational unit for force measurements.
3. The built-in rated capacity limiter must be regularly serviced and checked as to its functional safety before starting operation. According to the accident prevention regulation §35 UVV “boom cranes” maintenance of the crane also includes regular checks of the rated capacity limiter.
4. In general, the rated capacity limiter does not adjust automatically to the various operating conditions of the crane. When changing the operating condition of the crane, the operator is therefore responsible for also changing the rated capacity limiter over to the new load-carrying capacity or load moment range. For this purpose, the manufacturers operating instructions for the built-in rated capacity limiter are to be observed. Safe operation of the device and accident-free operation of the crane depend to a high extent on careful observance of this instruction. An incorrectly adjusted rated capacity limiter, e.g. set to a high load moment with retracted outriggers, is much more dangerous than a crane without a rated capacity limiter, because as a result the crane operator is given a wrong feeling of safety; this can be the cause of serious accidents.

## Appendix: Important information for crane operators and users

5. When changing the crane over to various operating conditions, the built-in rated capacity limiter (overload cut-off device) must be changed over to the new load-carrying capacity or load moment ranges respectively by the crane operator, e.g.:
  - a) when extending or retracting the outriggers (changing over to high or low load moment)
  - b) when changing the boom length by:
    - extending or retracting (telescoping) manually
    - mounting or dismounting connecting pieces
  - c) when slewing or pivoting the crane to the range of greater or smaller stability moment (changing over to high or low load moment)
  - d) when passing into another load capacity range by repeated reeving of hoisting lines in the hoisting gear or boom hoist unit
  
6. It must be expressly pointed out that due to the incorrect operation of the crane it might not be possible for the rated capacity limiter to respond and/or that the engine might not be switched off quickly enough. In this case you cannot completely exclude the possibility of accidents despite a built-in rated capacity limiter. In particular, this applies to:
  - underhooking the load or the load handling accessories
  - excessive retardation forces
  - loads falling into the line
  - diagonal pull
  - moving the crane to an area of higher gradient
  - yielding ground
  - wind pressure
  
7. If there is a device available to switch off or bypass the rated capacity limiter (load moment limiting system), it must only be used with account being taken of special safety measures and in the presence of the crane supervisor, for instance when testing the crane and for special applications provided for by the crane manufacturer.

**Careful observance of the regulations contained in this code of practice and in the operating instructions of the crane manufacturer is the precondition for the safe functioning of the rated capacity limiter (overload cut-off device).**

**In all cases of doubt the operating instructions of the manufacturer should be consulted. If this is not sufficient, further inquiry at the company concerned is necessary.**

**Unauthorised interventions in the mechanism of the rated capacity limiter will render the warranty void.**

**Publisher:** VDMA Fachgemeinschaft für Hebezeuge und Fördermittel  
im Verein Deutscher Maschinenbau-Anstalten e.V.  
Düsseldorf-Oberkassel

Appendix: Important information for crane operators and users

#### **CODE OF PRACTICE 4 Instructions to ensure the electromagnetic compatibility (EMC) with electronic systems under the effect of electromagnetic fields**

Electromagnetic fields increasingly affect electronic systems and can thus cause malfunctions. In the following we therefore indicate preventive measures according to the current state of technology:

1. The preventive measures are mainly based upon the idea of shielding the electronic circuits from irradiated high frequency interferences by means of a closed, low-impedance protective skin.
  - All components shall be provided with metal outer casings with an earthing capability;
  - Only cables with braided shields shall be used. The shield applied must be highly conductive at all connectors over a wide area;
  - Coupling of crane earth and electronic earth at only one single point of the system.
2. The general measures listed in item 1, however, cannot ensure complete protection against electromagnetic fields in individual cases because the size and the type of the effect depends on the local conditions.

Such influencing factors include:

- particularly unfavourable arrangement of the aerials to the system,
- very high transmitting powers,
- impossible to observe the measures in item 1 consistently due to local conditions,
- long cables,
- interferences coupling into the supply lines.

With unfavourable conditions it is therefore not possible to avoid taking measures experimentally on site, which exceed the preventive precautions, taking into account the principles mentioned in item 1, e.g.:

- Adding filters or short-circuiting the interfering frequencies by means of capacitors,
- Making or removing earth connections,
- Using double shielded cables (guarded shield system).

Appendix: Important information for crane operators and users

### **CODE OF PRACTICE 5 Information for occupational safety during the repair of display and operating consoles**

**Caution:** LCD displays contain liquid chemical substances in the display interior. Particular caution and care is therefore necessary when:

- operating devices which have LCD displays
- storing or transporting them (risk of fracture!)
- disposing of surplus or no longer usable LCD displays

**Possible risk causes are chemical reactions in case of skin contact with broken LCD displays. In case of contact with chemicals, carefully clean with soap the affected parts of the body. Particular caution is necessary in case of open wounds!**



### **CODE OF PRACTICE 6 Installation instructions for display and operator's consoles without a closed metal casing**

In order to prevent radio interferences, high frequency devices and systems subject to the general approval, which the Federal Minister of the Post Office and Telecommunications published in the official gazette no. 163/1984 as order no. 1045/1984 and no. 1046/1984, have to observe the limits and requirements stipulated therein.

In the case of display and operator's consoles without a closed metal casing (instrument panel-mounted) type, the cable shield must therefore be applied via a bare cable grip onto the instrument panel directly in front of the console.

## Revision History

<b>Revision</b>	<b>Date</b>	<b>Modifications</b>	<b>Name</b>
Rev. 001	2005-03-07	Original issue in English system program G53T V 2.0 (6.12.2004)	Konopka

